

Obrazová příloha kanoe **SCOUT** / SCOUT ECONOMY

VERZE 2/2021

CZ: Obrazová příručka
SK: Obrazová príručka
GB: Illustration Spread
D: Anlage mit Bildern
F: Annexe de figures
E: Anexo de imágenes

I: Appendice Figure
NL: Gedllustreerde bijlage
PL: Załącznik z ilustracjami
H: Képes melléklet
R: Иллюстративное руководство



1

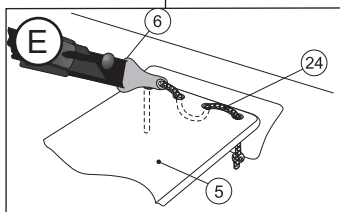
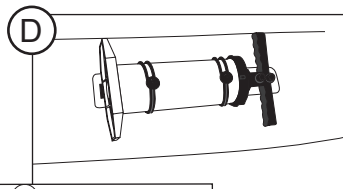
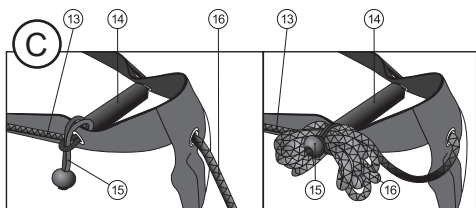
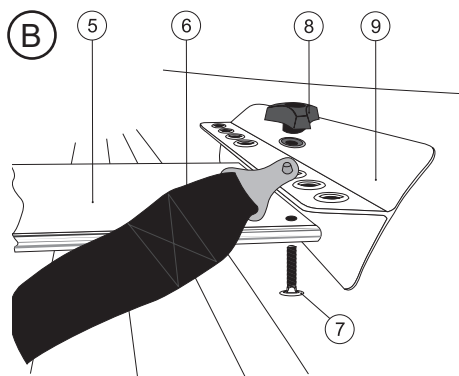
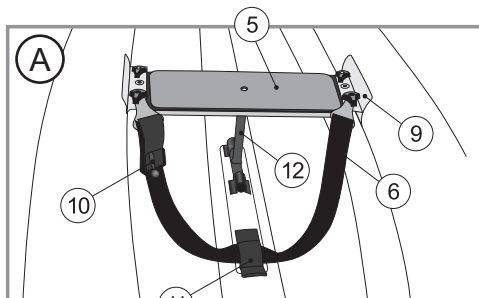
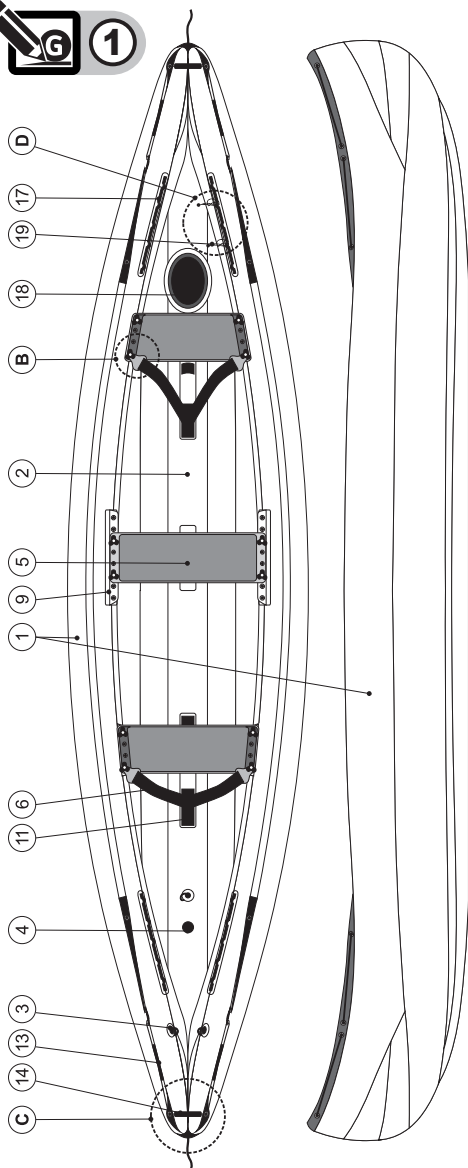

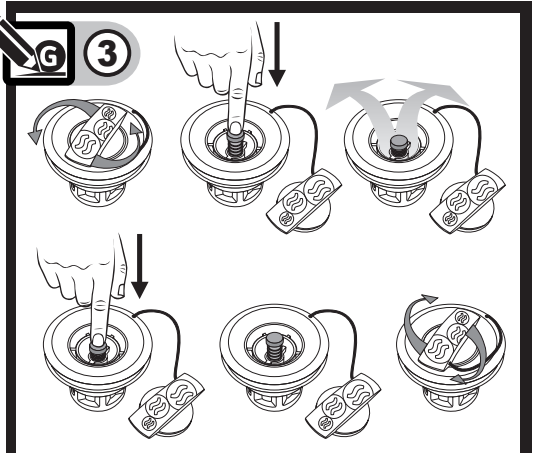
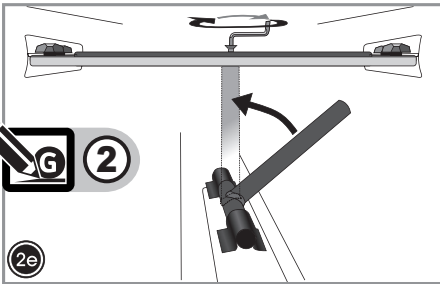
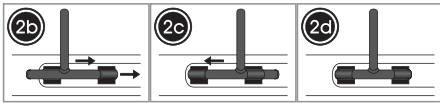
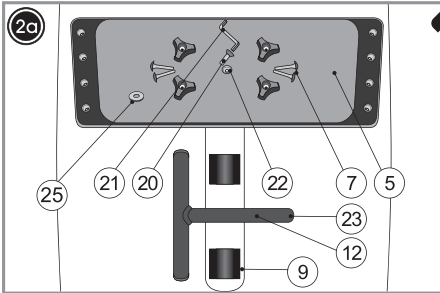

3a



3b



3c

